

WATER HEATERS



LEO
WATER HEATERS





LEO FL



10–53 kW
800–4200 m³/h

- light, functional design
- aesthetic finishing
- durability
- rotary 3D-console

PAGE 10

LEO FB

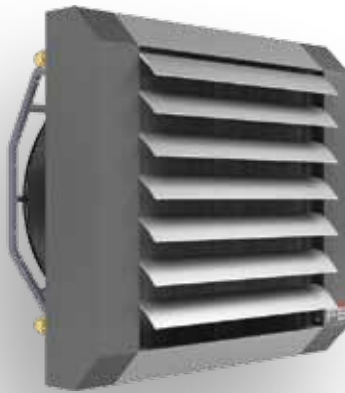

2–100 kW
150–8500 m³/h

- most economic
- easy and simple mounting
- 3D-console and other accessories
- considerable weight reduction*
- Leo FB 15 M-type equipped with energy-saving EC fan.

* in relation to common steel casing

PAGE 14

LEO FS



5–19 kW
230–1750 m³/h

- installation covered by the casing
- available with mixing chamber - KMFS
- ideal for elegant buildings
- M type units equipped with EC fan (electronically commutated)

PAGE 16

PAGE 25



LEO
FX

LEO
KM

LEO
D

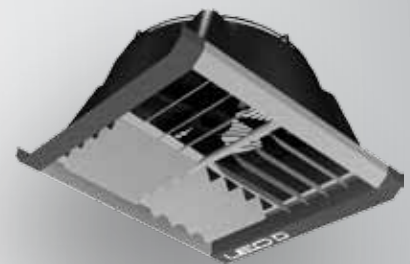

10–65 kW

700–4500 m³/h

Special purpose devices:

- EX - explosion-proof
- INOX - food industry
- EL - electrical heater
- AGRO - agricultural buildings

9–51 kW

540–3200 m³/h

- simplest mechanical ventilation
- automatic control and anti-freeze protection*

* optional equipment

-

5100–10200 m³/h

- maintains warm air within the comfort zone
- max. mounting height 12 m
- reduces heat losses

LEO
EX

PAGE **18**

LEO
INOX

PAGE **19**

LEO
EL

PAGE **19**

LEO
AGRO

PAGE **20**

PAGE **24**

PAGE **28**

intelligent air flow

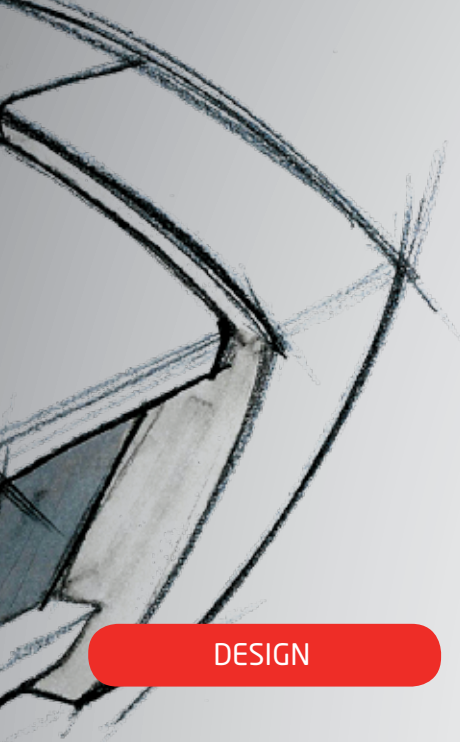

DESIGN

WATER HEATERS DON'T HAVE TO BE UGLY!

The appearance of LEO heaters is a result of cooperation between FLOWAIR and a Polish designing studio. The designers from STUDIO 1:1 are excellent and experienced specialists who do not hesitate to apply new technologies and materials in practice. Synergy of that cooperation can be visible in the implemented innovative solutions. Optimal technical parameters are combined with modern look and an unique control system.

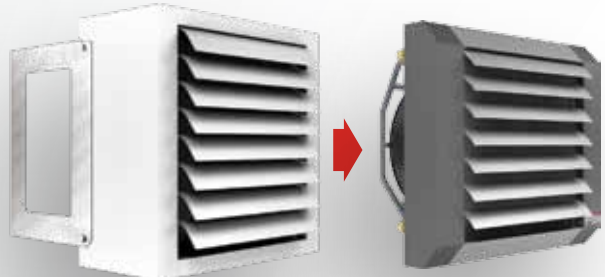
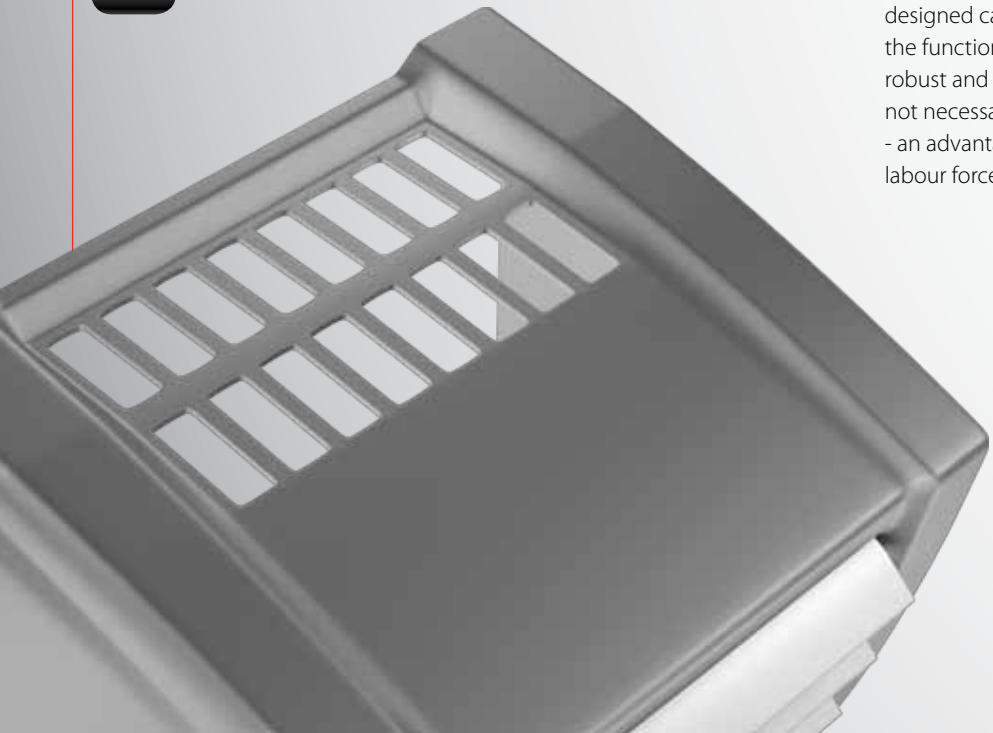

35 kg

17 kg

LIGHTWEIGHT

1

NOW YOU NEED LESS EFFORT AND CRAFTSMANSHIP TO MOUNT THE UNIT! QUALITY AND COMFORT DOES NOT ALWAYS MEAN A LARGE SIZE BOX.

Thanks to the applied production technologies our heaters are the lightest devices in their category! Weight reduction of LEO units was possible due to especially designed casings which improved the functionality of the units. Thanks to that robust and heavy supporting structures are not necessary. Easy and quick to mount - an advantage for you because of reduced labour force and working hours.

FLOWAIR INNOVATIVE SOLUTIONS



foto: T.Komiński



FUNCTIONAL

EACH STAGE OF THE HEATER'S LIFE IS IMPORTANT TO US: FROM ORDERING TO MOUNTING AND SERVICE.

The main assumption made during designing the LEO heaters was their functionality. A consumer - friendly product - this idea was a must for us! While designing we had to bear three things in mind: the users comfort, technical parameters and modern design.

Particular components of the structure are analyzed in detail by technologists, engineers and industrial designers.

As a result of applying those criteria LEO heaters reveal many advantages:

- Light weight
- Easy mounting
- Ergonomic consoles with a lot of mounting options
- Lowered noise level
- Improved service life.



2

MODERN

FLOWAIR IS A PART OF THE STRUCTURE FORMING THE POMERANIAN SCIENCE AND TECHNOLOGY PARK (PSTP).

Logistic centers, tennis halls, churches, workshops and car halls, car-washes, shops, pubs, etc. are the places in which LEO integrates itself perfectly.

Thanks to cooperation with Pomeranian Science and Technology Park we've emphasized and implemented innovative designs and implementations in the scope of air heating and ventilation, taking into account modern design requirements, energy savings and application of unique control methods.

3

intelligent air flow



3D-CONSOLES

YOU MOUNT LEO HOW AND WHERE YOU WANT IT

Dedicated mounting consoles have been designed for easy, quick and aesthetic mounting of LEO heaters. They provide unlimited mounting options for the units in various positions and almost anywhere: walls, posts under the ceiling vertically or at an angle.

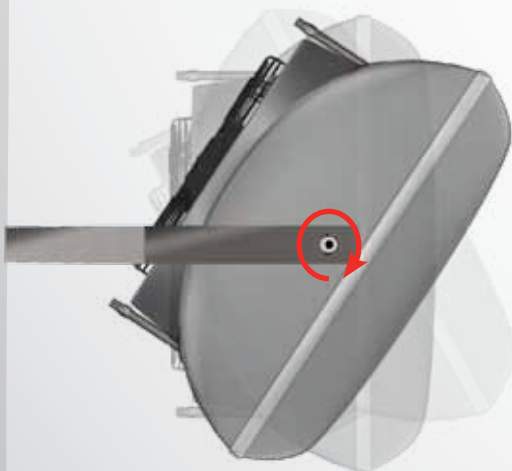
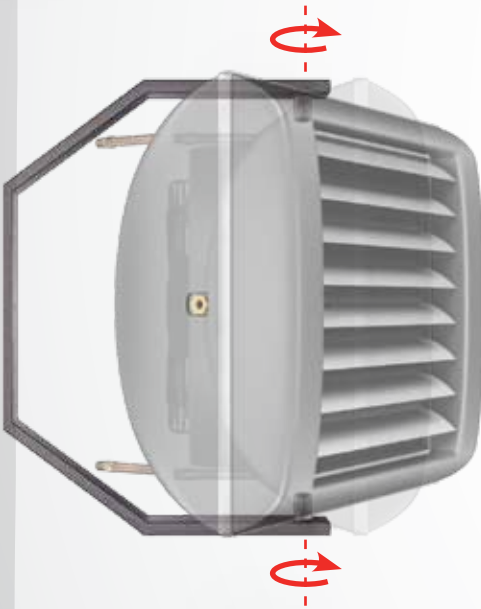

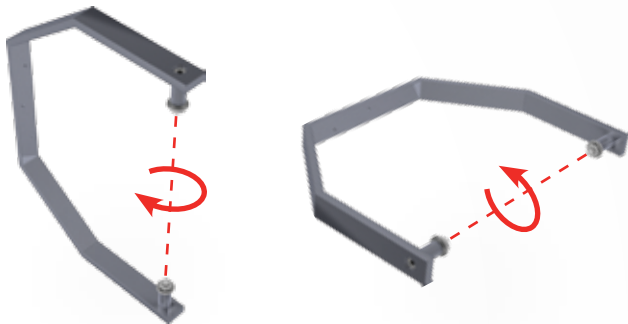
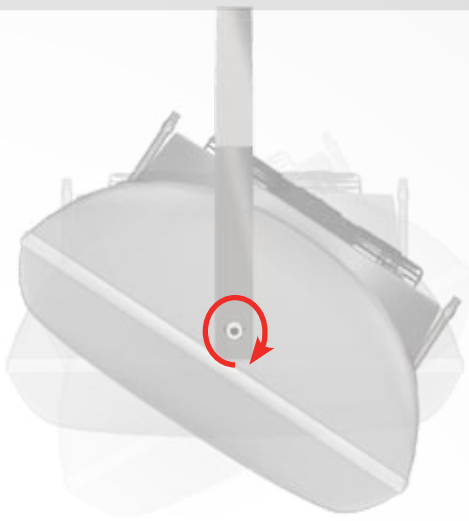

LEO
FL

PAGE 10

FL ROTARY CONSOLE

The heater can be mounted either vertically or horizontally. The unit can be rotated around its axis.

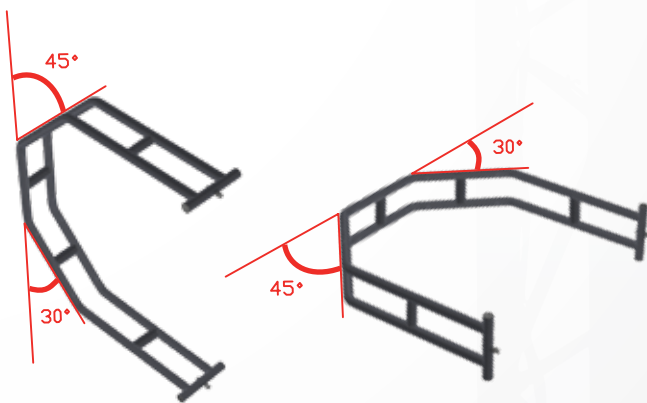

LEO
FB

PAGE 14

FB CONSOLE

The heater can be mounted at an angle of 30° or 45° to the mounting surface. The console can be mounted either vertically or horizontally in relation to the unit.

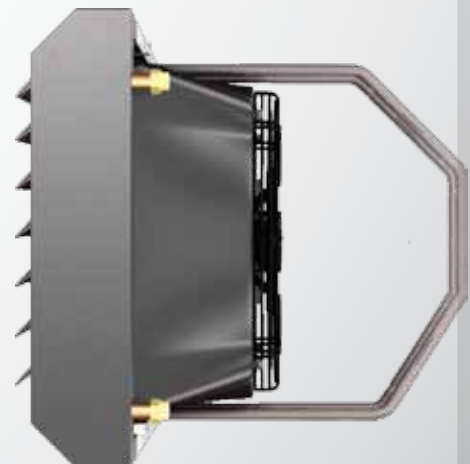



M SYSTEM

COMFORTABLE AND ECONOMIC CONTROL IS BASED ON MODULATED OPERATION OF THE HEATER

- Airflow and heat capacity are automatically controlled depending on actual temperature.
- Heating power is adjusted to current heat demand of the building.
- Follow-up system: each change of temperature in the room results in quick adjustment of the unit.

OPERATION

Room temperature is continuously measured and heating capacity is adjusted to current demands.

M System operation results in minimal consumption of heat and electrical energy and minimizes the noise level.

Each change in room temperature (e.g. gate opening) causes quick adjustment of the unit to the new conditions.

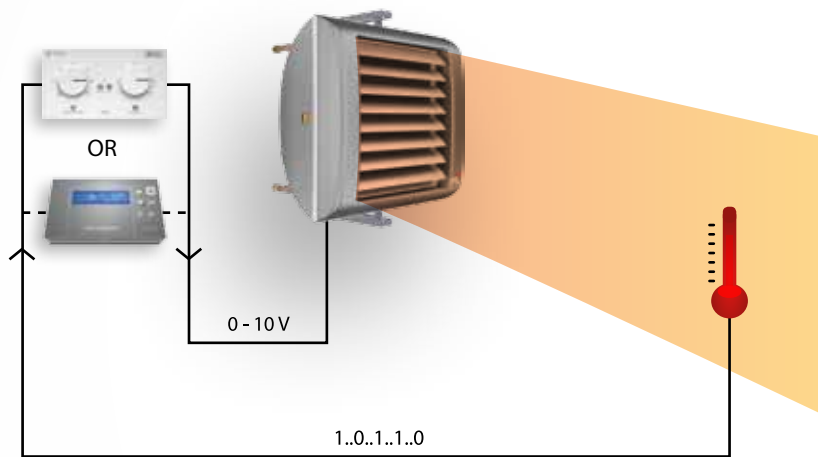

COMFORT

- Maintains temperature in the room at the required level (keeping comfortable temperature).
- Fully automatic control.
- Weekly calendar programming option.
- Very low inertia of the M system - quick response to temperature changes.



INNOVATIVE FLOWAIR SOLUTIONS

M SYSTEM

TEMPERATURE DIAGRAM

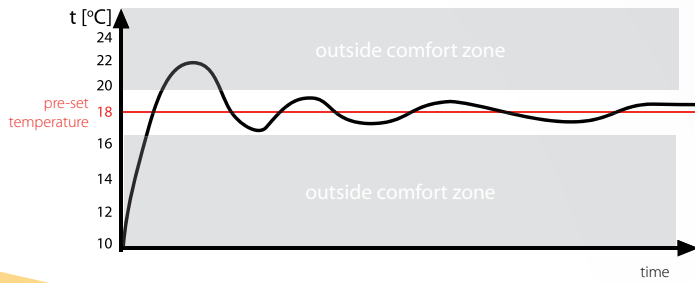

FAN OPERATION DIAGRAM

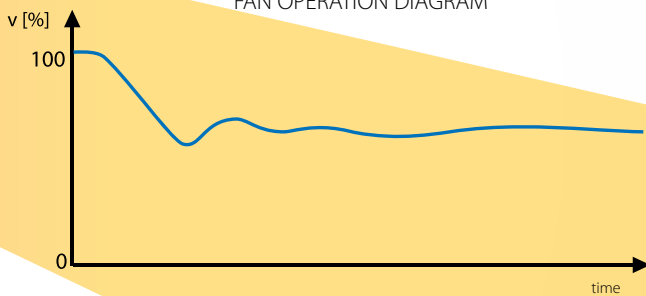

ON/OFF CONTROL

TEMPERATURE DIAGRAM

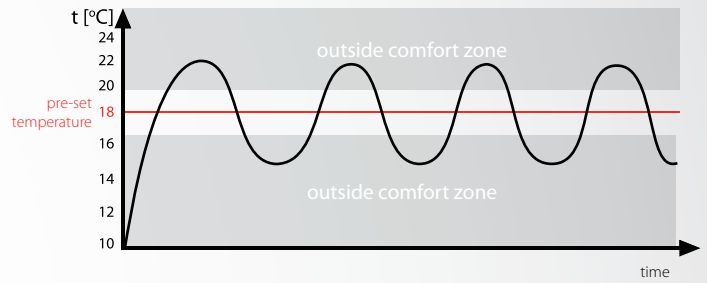

FAN OPERATION DIAGRAM

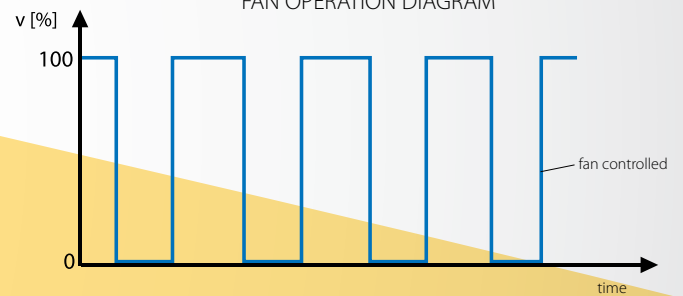

OPERATIONAL SAVINGS

- Low thermal energy consumption
- Unit supplies as much heat as it is actually demanded

INVESTMENT SAVINGS

- Lower expenses in the case of installation w/o valves
- One controller up to 10 devices

ECONOMY



QUIETNESS

- Fan operates at the lowest available speed to keep thermal comfort.
- No rapid on / off switching of the fan

QUIETNESS



ADDITIONALLY

- ANTIFREEZE function preventing freezing (optional system setup in a stand-by mode)
- Manual or automatic mode control system operation (manual selection of the fan speed).
- Possibility of connecting an external sensor PT, which allows measuring temperature away from the control panel.
- M system can be integrated with other devices, including BMS system.



Heating capacity	10–53 kW
Air flow	800–4200 m ³ /h
Weight	20,2–23,6 kg
Color	grey
Casing	ABS antistatic
Finishing	anodized aluminium



CASING

It is made of ABS – antistatic plastic. Due to the modern look, the heaters are fit for buildings of highest aesthetic demands. Use of plastic results in substantial weight reduction. The casing does not transfer any mechanical loads.

AIR BLADES

Stepless regulation of the air outlet angle of delivered air. They are made of anodized aluminium form an aesthetic finish of the device.

FAN

Special shape of blades for quiet operation. Optional stepless fan capacity regulation by the special control system (LEO FL type M). Blades made of plastic to reduce the device weight.

ROTARY 3D-CONSOLE

The heater can be mounted parallel to the wall or at an angle of 45°. It is possible to rotate it around connection points.

AIR NOZZLE

Thanks to its design the nozzle distributes the delivered air onto the whole surface of the exchanger. It considerably reduces the noise level.

LEO FL 30					LEO FL 50				
V = 4 200 m ³ /h					V = 3 700 m ³ /h				
Tp1	PT	Qw	Δpw	Tp2	PT	Qw	Δpw	Tp2	
°C	kW	l/h	kPa	°C	kW	l/h	kPa	°C	
Tw1/Tw2 = 90/70°C									
0	29,6	1270	12,2	18,9	52,7	2330	15,2	39,5	
5	26,8	1126	10,6	22,8	48,7	2150	13,3	42,1	
10	24,3	1080	9,1	26,6	44,7	1980	11,4	44,7	
15	22,1	990	7,8	30,4	40,8	1810	9,7	47,3	
20	20,0	890	6,6	34,2	37	1640	8,2	49,7	
Tw1/Tw2 = 80/60°C									
0	24,4	1080	9,6	16,1	45,3	2000	12,0	33,9	
5	22,3	990	8,1	20,0	41,2	1820	10,2	36,5	
10	20,1	890	6,8	23,8	37,4	1650	8,6	39	
15	18,0	800	5,6	27,6	33,6	1480	7,2	41,5	
20	16	710	4,6	31,3	29,8	1320	5,8	44	
Tw1/Tw2 = 70/50°C									
0	20,2	890	7,1	13,3	37,7	1660	9,0	28,3	
5	18,1	800	5,8	17,2	33,8	1490	7,5	30,8	
10	16	710	4,7	20,9	30	1320	6,1	33,3	
15	13,9	620	3,7	24,7	26,3	1160	4,8	35,8	
20	11,9	530	2,9	28,5	22,6	1000	3,7	38,2	



Power supply	230 V/50 Hz
Max power consumption	280 W
Max current consumption	1,2 A
IP/Insulation class	54/F
Acoustic pressure level	50 dB(A)

Acoustic pressure level measured in the room of average sound absorption, capacity 1500m³, at distance of 5m from the unit.



Max. water temperature	95°C
Max. water pressure	1,6 MPa (16 bar)

Technical data concerning supplying with other water parameters are available upon request at Sales office.

- V – air flow
- PT – heating capacity
- Tp1 – inlet air temperature
- Tp2 – outlet air temperature
- Tw1 – inlet water temperature
- Tw2 – outlet water temperature
- Qw – heating water stream
- Δpw – water pressure drop



Weight [kg]	FL 30	FL 50
Unit	20,2	22
Unit filled with water	21,2	23,6
Air stream range [m]	FL 30	FL 50
L*	26	24

* range of isothermal horizontal stream, limit speed 0,5 m/s

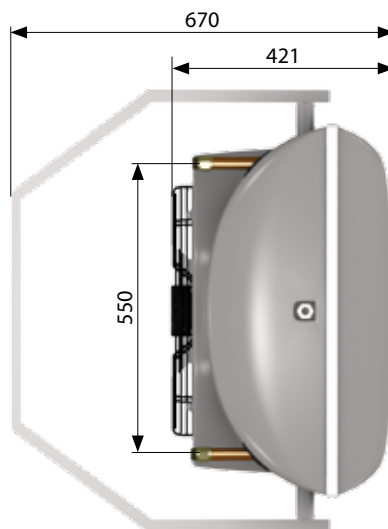
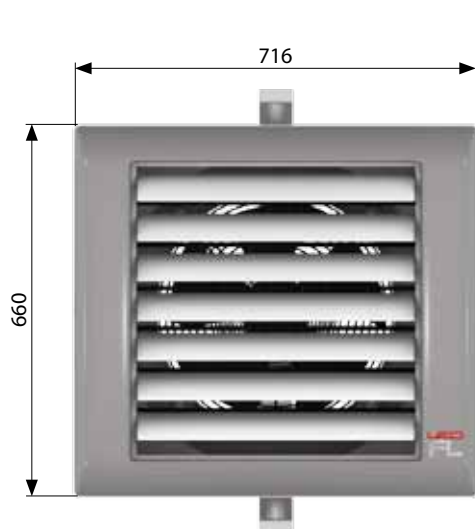

Connecting stub 3/4"

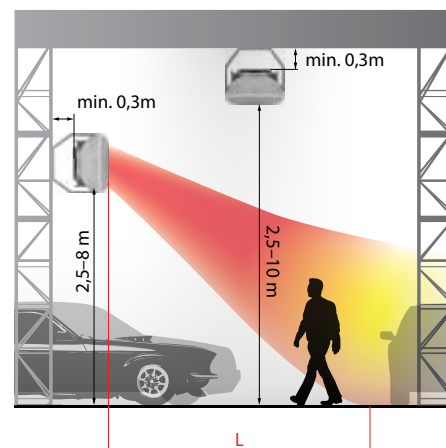

Heating capacity	2–100 kW
Air flow	150–8500 m ³ /h
Weight	11,3–38 kg
Color	silver-grey
Casing	sheet steel + plastic

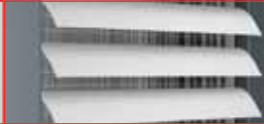

CASING

Main part is made of sheet steel. Special layer of powder coating makes it resistant to fine scratches and dirt. Light-weight, does not require any heavy supporting elements. Attractive, modern style combines the best features of metal and plastic.

AIR BLADES

Mounted either vertically or horizontally. Independently regulated blades for stepless change of air outlet angle.

FAN

Ensures delivery of heated air to the room. Energy efficient - power consumption from 57,5W in Leo FB 15 M type with EC (Electronically Commutated) motor to 560W in Leo FB 95. Blades made of plastic to reduce the weight. Special shape of blades results in quiet operation of the heater.

3D-CONSOLE

Specially designed for LEO FB. It can be mounted either horizontally or vertically in reference to the unit. Additionally two angles of mounting are available (30° or 45°).

DRAIN PAN

Unit equipped with drain pan can be used as a conditioner. Drain pan removes accumulated water from the casing in controlled way. Cooling capacities are available in sale office, please contact local dealer.



U-PROFILE FOR CEILING-MOUNTING

Levelling and mounting by rods is easier.



APPLICATION

Leo water heaters are the ideal solution for users, who need high-efficiency heating units, while the design is also important. Highest quality components, supplied by renowned European producers were used to assemble the units. Thanks to modern design and optimal technical parameters

Leo heaters can be mounted in buildings like:

- industrial buildings
- workshops
- car show rooms
- warehouses
- pavilions
- sports halls
- exhibitions halls
- assembly hall
- supermarkets
- churches

LEO
FB

		LEO FB 9				LEO FB 15				LEO FB 25			
		V = 2000 m ³ /h				V = 2000 m ³ /h				V = 4400 m ³ /h			
Tp1	PT	Qw	Δpw	Tp2	PT	Qw	Δpw	Tp2	PT	Qw	Δpw	Tp2	
°C	kW	l/h	kPa	°C	kW	l/h	kPa	°C	kW	l/h	kPa	°C	
Tw1/Tw2 = 90/70°C													
0	8,9	392	2,3	14,5	17,4	769	6,9	28,7	25,4	1121	11,7	16	
5	8,2	363	2,0	19,0	16,1	711	6	32	23,5	1037	10,1	20	
10	7,6	333	1,7	23,0	14,8	655	5,2	35,3	21,6	953	8,7	24,1	
15	6,9	304	1,5	27,0	13,6	599	4,4	38,5	19,7	871	7,4	28,1	
20	6,3	276	1,2	31,0	12,3	544	3,7	41,7	17,9	790	6,2	32,1	
Tw1/Tw2 = 80/60°C													
0	7,5	331	1,8	12,0	14,9	656	5,3	24,6	21,6	950	8,9	13,6	
5	6,9	302	1,5	16,0	13,6	599	4,5	27,9	19,7	867	7,5	17,6	
10	6,2	273	1,3	20,0	12,4	544	3,8	31,1	17,9	785	6,3	21,6	
15	5,6	244	1,0	25,0	11,1	489	3,1	34,3	16	704	5,1	25,6	
20	4,9	216	0,8	29,0	9,9	435	2,5	37,4	14,2	624	4,1	29,6	
Tw1/Tw2 = 70/50°C													
0	6,2	269	1,3	10,0	12,4	542	3,9	20,4	17,8	779	6,4	11,2	
5	5,5	240	1,0	14,0	11,1	487	3,2	23,7	15,9	697	5,2	15,2	
10	4,8	211	0,8	18,0	9,9	432	2,6	26,8	14,1	617	4,2	19,2	
15	4,2	182	0,6	22,0	8,6	378	2	30	12,3	537	3,2	23,1	
20	3,5	153	0,5	26,0	7,4	324	1,6	33,1	10,5	457	2,4	27	

Weight [kg]	FB 9	FB 15	FB 25	FB 45	FB 65	FB 95
Unit	11,3	12	16,9	18,1	20,4	34,5
Unit filled with water	12	13,2	17,9	20,1	23,1	38
Dimensions [mm]	FB 9	FB 15	FB 25	FB 45	FB 65	FB 95
A	500	500	600	600	600	600
B	540	540	640	640	640	1175
C	525	525	610	610	630	610
D	335	335	350	350	370	350
E	345	345	440	440	440	440
Recommended dist. of mounting [m]	FB 9	FB 15	FB 25	FB 45	FB 65	FB 95
F	max 3	max.3	2,5-8	2,5-8	2,5-8	2,5-10
G	2,5-5	2,5- 5	2,5-10	2,5-10	2,5-10	2,5-12
H	min.0,25	min.0,25	min.0,3	min.0,3	min.0,3	min.0,3
Air stream range [m]	FB 9	FB 15	FB 25	FB 45	FB 65	FB 95
L*	14	14	26	24	22	33

* range of isothermal horizontal stream, limit speed 0,5 m/s

LEO FB 45					LEO FB 65				LEO FB 95			
V = 4100 m ³ /h					V = 3900 m ³ /h				V = 8500 m ³ /h			
Tp1	PT	Qw	Δpw	Tp2	PT	Qw	Δpw	Tp2	PT	Qw	Δpw	Tp2
°C	kW	l/h	kPa	°C	kW	l/h	kPa	°C	kW	l/h	kPa	°C
Tw1/Tw2 = 90/70°C												
0	46,8	2067	17,5	31,6	64,6	2660	36,8	46,1	100,1	4418	55,7	32,6
5	43,3	1911	15,2	34,7	60,2	2464	32	48,4	92,7	4091	48,3	35,7
10	39,8	1758	13	37,8	55,4	2272	27,6	50,7	85,4	3771	41,5	38,8
15	36,4	1607	11	40,9	50,1	2084	23,6	52,9	78,3	3456	35,3	41,8
20	33,1	1459	9,2	43,9	46,2	1899	19,9	55,1	71,3	3146	29,7	44,8
w1/Tw2 = 80/60°C												
0	40,1	1762	13,4	27,1	56,1	2288	28,7	39,8	86,3	3790	43	28,1
5	36,6	1610	11,4	30,2	51,3	2097	24,5	42,1	79	3470	36,5	31,2
10	33,2	1459	9,5	33,2	46,7	1909	20,7	44,3	71,8	3156	30,7	34,2
15	29,9	1312	7,8	36,2	42,1	1725	17,2	46,5	64,8	2847	25,4	37,2
20	26,5	1166	6,3	39,2	37,6	1543	14,1	48,6	57,9	2543	20,6	40,2
Tw1/Tw2 = 70/50°C												
0	33,3	1459	9,8	22,5	47,1	1919	21,5	33,4	72,4	3167	31,7	23,6
5	29,9	1309	8,1	25,6	42,5	1731	17,9	35,6	65,2	2854	26,2	26,6
10	26,6	1162	6,5	28,6	37,9	1547	14,6	37,8	58,2	2545	21,3	29,6
15	23,2	1017	5,1	31,5	33,4	1366	11,6	39,9	51,2	2242	16,9	32,6
20	20	874	3,9	34,4	28,9	1187	9,1	42	44,4	1942	13	35,5

V – air flow
PT – heating capacity
Tp1 – inlet air temperature
Tp2 – outlet air temperature

Tw1 – inlet water temperature
Tw2 – outlet water temperature
Qw – heating water stream
Δpw – water pressure drop

**LEO
FB**

	FB 9 15		FB 25 45 65		FB 95
Type	S	M	S & M	S & M	
Max. power consumption	92 W	57,5 W	280 W	560 W (2x280 W)	
Max. current consumption	0,4 A	0,25 A	1,2 A	2,4 A (2x1,2 A)	
Type of fan	AC	EC	AC	AC	
Power supply	230 V/50 Hz		230 V/50 Hz	230 V/50 Hz	
IP/Insulation class	54/F		54/F	54/F	
Acoustic pressure level	45 dB(A)		51 dB(A)	53 dB(A)	

Acoustic pressure level measured in the room of average sound absorption, capacity 1500m³, at distance of 5m from the unit.

	FB 9 15	FB 25 45 65	FB 95
Max. water temperature	95°C	130°C	130°C
Max. water pressure	1,6 MPa	1,6 MPa	1,6 MPa

Technical data concerning supplying with other water parameters are available upon request at Sales office.

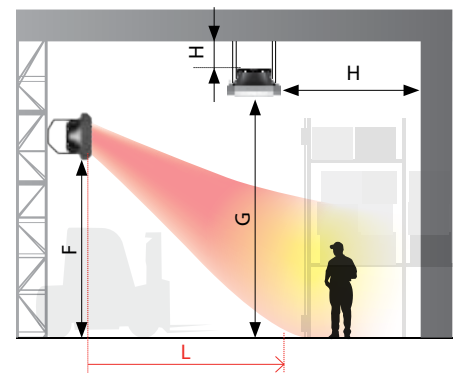
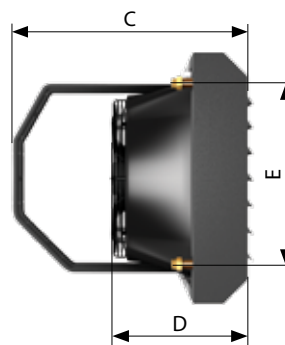
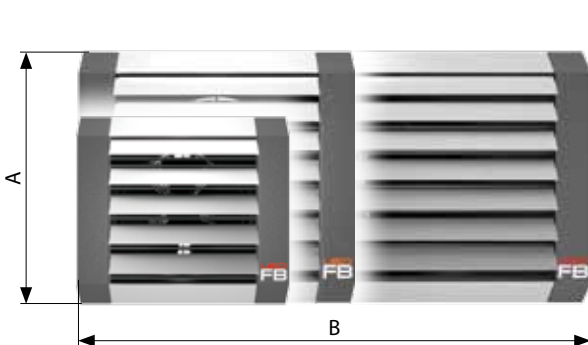

Connecting stub ¾" and ½"(LEO FB 9|15)

Heating capacity	5–19 kW
Air flow	230–1750 m ³ /h
Weight	13,8–15 kg
Color	grey
Casing	ABS antistatic



CASING

It is made of ABS – antistatic plastic. Inclined by 15° towards the room directs the heated air directly onto the occupied area. **It covers completely the heating and electrical installation.**

AIR BLADES

For stepless regulation of the air outlet angle. Made of anodized aluminium to form an aesthetic finish for the unit.

EC FAN

Low electrical power consumption - only 57,5W in M type with EC (Electronically Commutated) motor.

HEAT EXCHANGER

19 kW power adjusted for small and medium area. Connecting pipes ½" come out to the back of the device to make hiding the heating installation beneath the casing possible.

AIR NOZZLE

Directs the blown air onto the whole surface of the exchanger. Its specially designed profile made of plastic reduces noise generated during air flow.

LEO FS				
V = 1 750 m ³ /h				
Tp1	PT	Qw	Δpw	Tp2
°C	kW	l/h	kPa	°C
Tw1/Tw2 = 90/70°C				
0	19,4	873	5,9	31,3
5	18,3	806	5,1	34,4
10	16,8	741	4,4	37,5
15	15,3	676	3,7	40,5
20	13,9	613	3,1	43,5
Tw1/Tw2 = 80/60°C				
0	16,9	741	4,5	26,7
5	15,4	676	3,8	29,7
10	13,9	611	3,2	32,8
15	12,5	548	2,6	35,7
20	11,0	485	2,1	38,7
Tw1/Tw2 = 70/50°C				
0	13,9	608	3,2	22,0
5	12,4	544	2,6	25,0
10	11,0	480	2,1	28,0
15	9,5	417	1,6	30,9
20	8,1	355	1,2	33,7



	LEO FS S	LEO FS M
Power supply	230 V/50 Hz	
Max. power consumption	92 W	57,5 W
Max. current consumption	0,4 A	0,25 A
IP/Insulation class	54/F	
Acoustic pressure level	45 dB(A)	

Acoustic pressure level measured in the room of average sound absorption, capacity 1500m³, at distance of 5m from the unit.



Max. water temperature	95°C
Max. water pressure	1,6 MPa

Technical data concerning supplying with other water parameters are available upon request at Sales office.

- V – air flow
- PT – heating capacity
- Tp1 – inlet air temperature
- Tp2 – outlet air temperature

- Tw1 – inlet water temperature
- Tw2 – outlet water temperature
- Qw – heating water stream
- Δpw – water pressure drop

LEO FS

Weight [kg]	LEO FS S / LEO FS M
Unit	13,8
Unit filled with water	15
Air stream range [m]	LEO FS S / LEO FS M
L*	12

* range of isothermal horizontal stream, limit speed 0,5 m/s

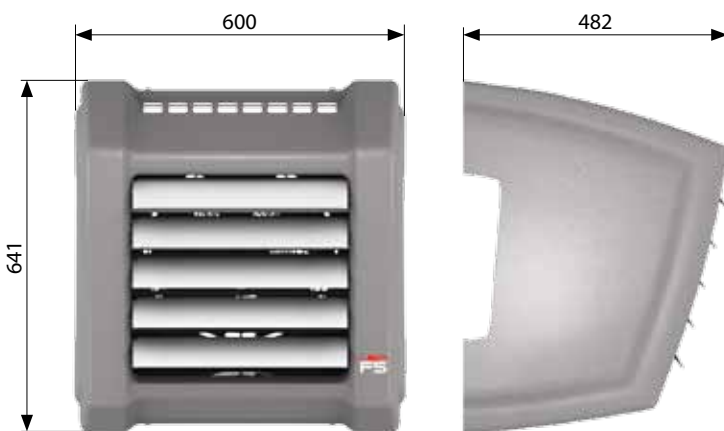

Connecting stub 1/2"

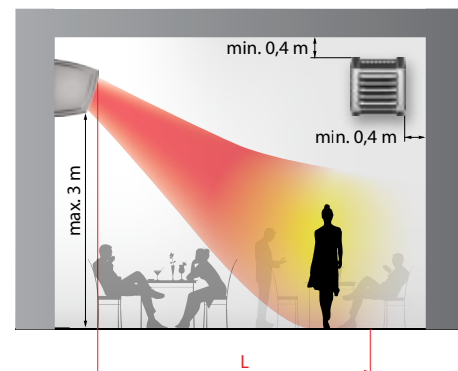



FLOWAIR offers a wide range of products dedicated to work under harsh environmental conditions. Special FX Series may be used in such facilities as car washes, live-stock farms, greenhouses, industrial halls, food production and areas threatened by explosion, etc.

Heating capacity	26–45 kW
Air flow	3 800–4 300 m ³ /h
Weight	33,1–36,6 kg
Color	grey
Casing	sheet steel



AIR NOZZLE

Directs the blown air onto the whole surface of the exchanger.
It specially designed profile made from plastic, reduces noise generated during air flow.

FAN

The heater is equipped with an explosion-proof fan. The blade ends are made of plastic and the motor casing prevents sparking. The device can be applied in explosion-hazard zone Z1, in areas of explosion hazard caused by flammable gas, vapours and liquids of explosiveness group IIA and IIB with temperature classes T1,T2 and T3.

SELECTION

To maintain maximal safety applied automatic control system and electrical connections should also be manufactured as explosion-proof and in at least the same class as the fan.
Automatic control system should be selected individually depending on the level of explosion hazard in building.



LEO
EL



Heating capacity	13,5/27 kW
Air flow	4500 m ³ /h
Weight	46,3 kg
Color	grey
Casing	sheet steel



LEO
INOX



Heating capacity	10–65 kW
Air flow	900–4400 m ³ /h
Weight	18–24 kg
Color	—
Casing	stainless steel



HEATING RODS

Six finned heating rods for increased efficiency of the heat transfer have been assembled. Specially shaped and located inside the casing and designed for the best air flow and utilization of heating capacity.



CONTROL SYSTEM

Complete supply control and protection system with room thermostat. There are three operation modes available. Summer mode: The fan is running constantly without heating. Two winter modes: half (13,5 kW) and full (27 kW) heating capacity. Control system protects heating rods and fan against overheat.



CASING

The casing made of stainless steel provides resistance to corrosive factors. A specially designed air nozzle directs the air stream onto the whole surface of the heat exchanger, therefore reduces the air flow losses and ensures quiet operation.



SELECTION

In order to select proper grade of Inox steel used for heater construction it is necessary to define precisely the working environment conditions: type of corrosive substances, pH, humidity, presence of organic compounds and substances, etc. The device should be cleaned on a regular basis to maintain its anti-corrosion properties.



Heating capacity	14–45 kW
Air flow	700–3700 m ³ /h
Weight	34,6–36,9 kg
Color	grey
Casing	steel



SPECIAL CASING INTERIOR

Specially profiled channel inside the casing – guiding air directly from the fan onto the heaters area and insulates the remaining space of the casing interior. It forces dirt to accumulate in an easy accessible area for cleaning (no tools required).

EPOXY-COATED EXCHANGER

Three row heat exchanger– large gap between the lamellas (4 mm) make cleaning with compressed air or pressurized water easier. Thicker lamellas used to avoid bending during cleaning. **EPOXY COATING- improved resistance to corrosive environments (e.g. extends resistance to ammonia).**

FAN

IP 66 insulation class. Plastic fan blades of increased thickness used for high abrasion and corrosion resistance. The fan was selected so that the growing resistance affects its operation as little as possible. Quick disassembly of the fan w/o any tools makes its cleaning easy.

ARM CONSOLE

There are two brackets available: Arm-console and expandable mounting brackets. Arm-Console is dedicated especially to henhouses for installing on the posts. Using this console user can turn unit in 180 range. It make possible to release transport / operating way inside e.g. chicken farm. Expandable mounting brackets can change the distance between wall and back side of unit. Dedicated for wall installation.

DRAIN PLUGS

It is situated on up and down side of heater casing. Water accumulated inside the unit during cleaning can be easily removed. Plugs installed on the up and down side makes possible to drain water even if unit is installed upside down.

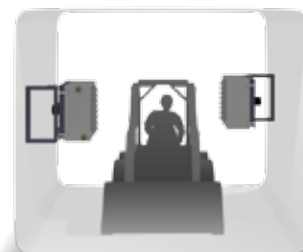
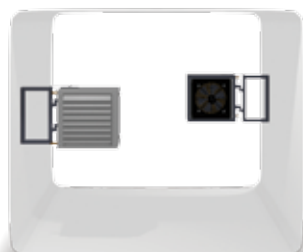

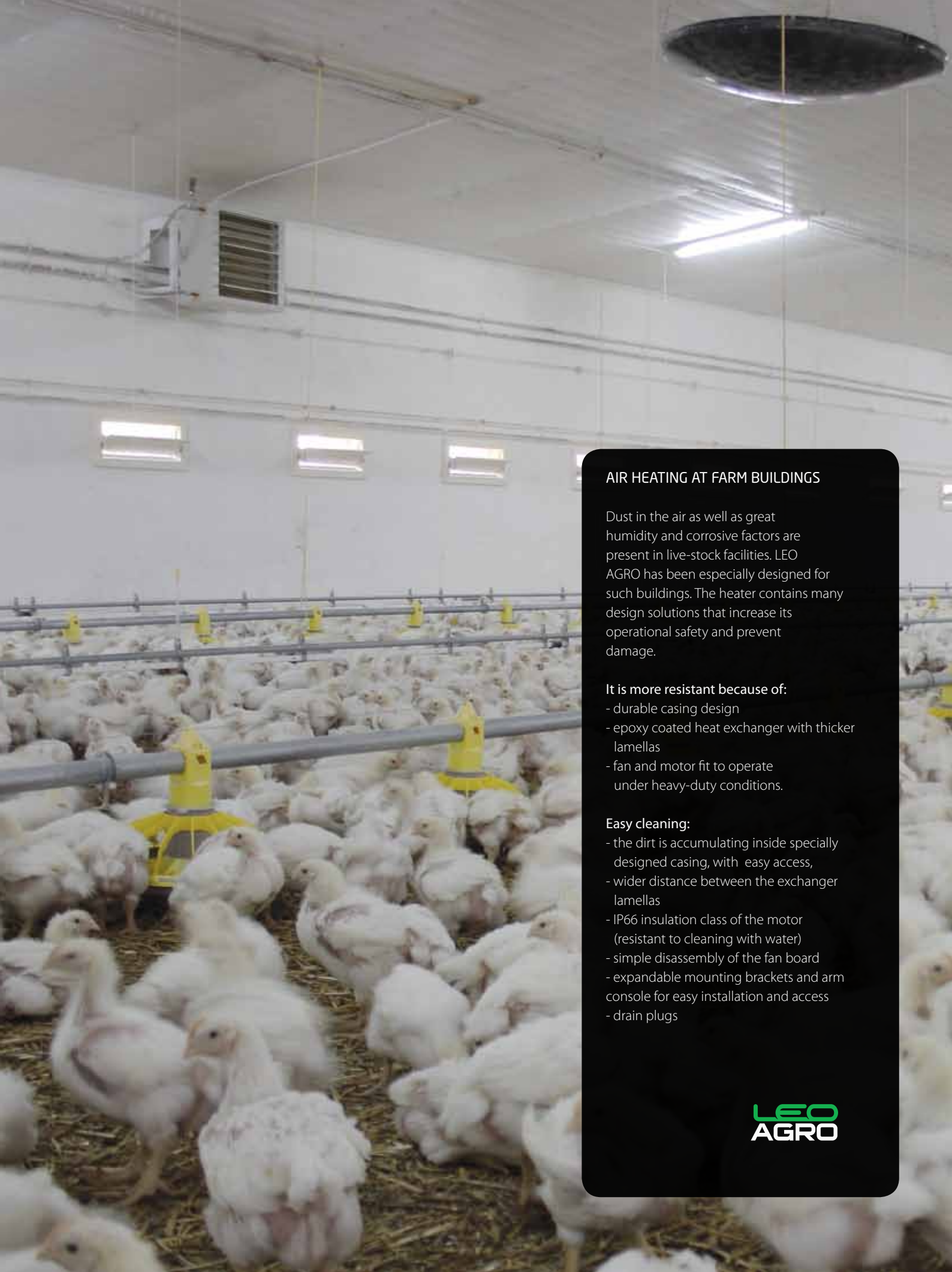

AIR HEATING AT FARM BUILDINGS

Dust in the air as well as great humidity and corrosive factors are present in live-stock facilities. LEO AGRO has been especially designed for such buildings. The heater contains many design solutions that increase its operational safety and prevent damage.

It is more resistant because of:

- durable casing design
- epoxy coated heat exchanger with thicker lamellas
- fan and motor fit to operate under heavy-duty conditions.

Easy cleaning:

- the dirt is accumulating inside specially designed casing, with easy access,
- wider distance between the exchanger lamellas
- IP66 insulation class of the motor (resistant to cleaning with water)
- simple disassembly of the fan board
- expandable mounting brackets and arm console for easy installation and access
- drain plugs

LEO
AGRO

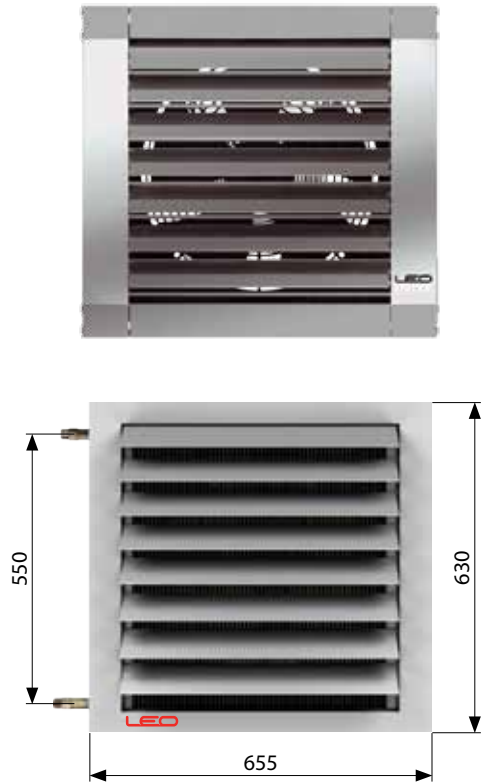

LEO INOX 25				LEO INOX 45				LEO INOX 65				
V = 4400 m ³ /h				V = 4100 m ³ /h				V = 3900 m ³ /h				
Tp1	PT	Qw	Δpw	Tp2	PT	Qw	Δpw	Tp2	PT	Qw	Δpw	Tp2
°C	kW	l/h	kPa	°C	kW	l/h	kPa	°C	kW	l/h	kPa	°C
Tw1/Tw2 = 90/70°C												
0	25,4	1121	11,7	16	46,8	2067	17,5	31,6	64,6	2660	36,8	46,1
5	23,5	1037	10,1	20	43,3	1911	15,2	34,7	60,2	2464	32	48,4
10	21,6	953	8,7	24,1	39,8	1758	13	37,8	55,4	2272	27,6	50,7
15	19,7	871	7,4	28,1	36,4	1607	11	40,9	50,1	2084	23,6	52,9
20	17,9	790	6,2	32,1	33,1	1459	9,2	43,9	46,2	1899	19,9	55,1
Tw1/Tw2 = 80/60°C												
0	21,6	950	8,9	13,6	40,1	1762	13,4	27,1	56,1	2288	28,7	39,8
5	19,7	867	7,5	17,6	36,6	1610	11,4	30,2	51,3	2097	24,5	42,1
10	17,9	785	6,3	21,6	33,2	1459	9,5	33,2	46,7	1909	20,7	44,3
15	16	704	5,1	25,6	29,9	1312	7,8	36,2	42,1	1725	17,2	46,5
20	14,2	624	4,1	29,6	26,5	1166	6,3	39,2	37,6	1543	14,1	48,6
Tw1/Tw2 = 70/50°C												
0	17,8	779	6,4	11,2	33,3	1459	9,8	22,5	47,1	1919	21,5	33,4
5	15,9	697	5,2	15,2	29,9	1309	8,1	25,6	42,5	1731	17,9	35,6
10	14,1	617	4,2	19,2	26,6	1162	6,5	28,6	37,9	1547	14,6	37,8
15	12,3	537	3,2	23,1	23,2	1017	5,1	31,5	33,4	1366	11,6	39,9
20	10,5	457	2,4	27	20	874	3,9	34,4	28,9	1187	9,1	42

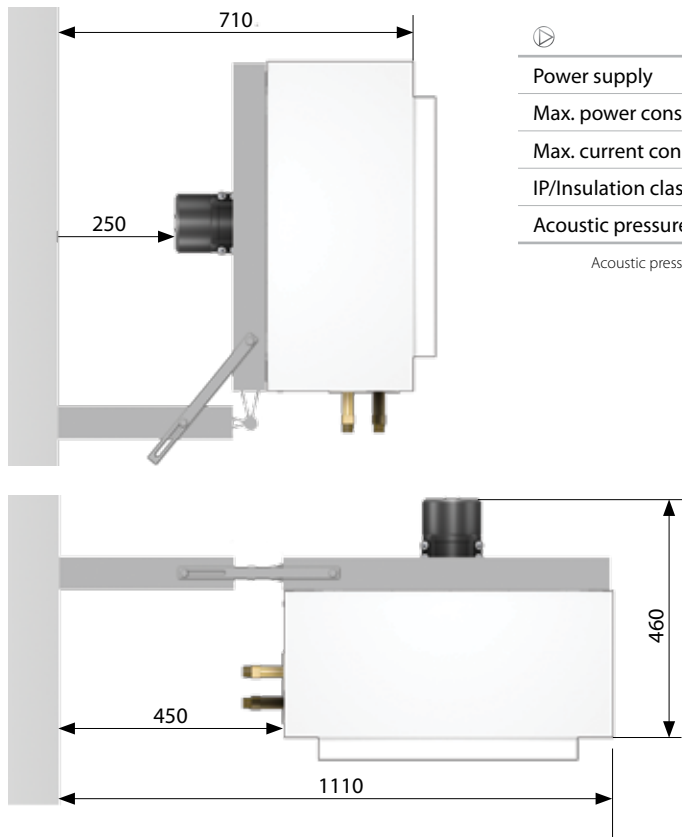

	EX 25/45	EL	INOX 25/45/65	AGRO 45
Power supply	3x400V/50 Hz	3x400V / 50Hz	230 V/50 Hz	230 V/50 Hz
Max. power consumption	290W	27kW	280W	415W
Max. current consumption	0,88 A	39 A	1,2 A	1,8 A
IP/Insulation class	44/F	20/-	54/F	66/F
Acoustic pressure level	51 dB(A)	51 dB(A)	51 dB(A)	51 dB(A)

Acoustic pressure level measured in the room of average sound absorption, capacity 1500m³, at distance of 5m from the unit.

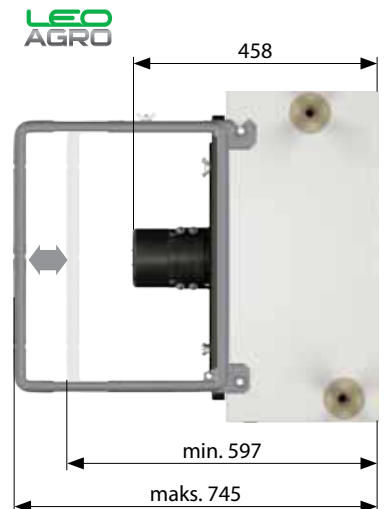

Connecting stub ¾"

LEO AGRO 45					LEO EX 25				LEO EX 45			
V = 3 700 m ³ /h					V = 4 300 m ³ /h				V = 3 800 m ³ /h			
Tp1	PT	Qw	Δpw	Tp2	PT	Qw	Δpw	Tp2	PT	Qw	Δpw	Tp2
°C	kW	l/h	kPa	°C	kW	l/h	kPa	°C	kW	l/h	kPa	°C
Tw1/Tw2 = 90/70°C												
0	44,9	1980	26,2	33,7	25,5	1090	7,6	17,4	44,9	1882	12,5	34,8
5	41,5	1830	22,8	36,7	23,7	1018	6,7	21,2	41,0	1738	11,0	36,5
10	38,3	1690	19,7	39,7	22	946	5,9	25	37,3	1630	9,7	39,1
15	35,0	1540	16,9	42,7	20,2	874	5,1	28,9	34,6	1476	8,3	41,9
20	31,9	1400	14,3	45,6	18,4	805	4,3	32,7	31,8	1368	7,1	44,7
Tw1/Tw2 = 80/60°C												
0	38,9	1710	20,9	29,1	21,7	946	5,9	15	37,2	1584	9,8	28,9
5	35,5	1560	17,9	32,1	20,0	874	5,1	18,7	34,4	1476	8,4	31,7
10	32,4	1420	15,2	35,1	18,2	802	4,4	22,5	31,5	1368	7,2	34,5
15	29,1	1280	12,7	38,1	16,5	730	3,7	26,3	28,6	1224	6,1	37,2
20	26,0	1140	10,4	40,9	14,8	658	3	30	25,7	1116	5	40
Tw1/Tw2 = 70/50°C												
0	32,8	1440	16,0	24,6	18	802	4,4	12,4	31,2	1340	7,4	24,2
5	29,6	1290	13,3	27,6	16,3	694	3,7	16,2	28,4	1225	6,3	27,0
10	26,4	1150	10,9	30,5	14,5	622	3	20	25,5	1080	5,2	29,8
15	23,3	1020	8,8	33,4	12,8	550	2,4	23,8	22,6	975	4,2	32,5
20	20,2	890	6,9	36,3	11,1	478	1,9	27,6	19,7	865	3,3	35,3



Max. water temperature	130°C
Max. water pressure	1,6 MPa

Technical data concerning supplying with other water parameters are available upon request at Sales office.

- V – air flow
- PT – heating capacity
- Tp1 – inlet air temperature
- Tp2 – outlet air temperature

- Tw1 – inlet water temperature
- Tw2 – outlet water temperature
- Qw – heating water stream
- Δpw – water pressure drop

LEO FX

Weight [kg]	EX 25	EX 45	EL	INOX 25	INOX 45	INOX 65	AGRO 45
Unit	33,1	34,5	46,3	18	19,4	21,3	34,6
Unit filled with water	34,2	36,6	–	19	21,4	24	36,9
Air stream range [m]	EX 25	EX 45	EL	INOX 25	INOX 45	INOX 65	AGRO 45
L*	24	22	23	26	24	22	22

* range of isothermal horizontal stream, limit speed 0,5 m/s

LEO
EX



LEO
EL

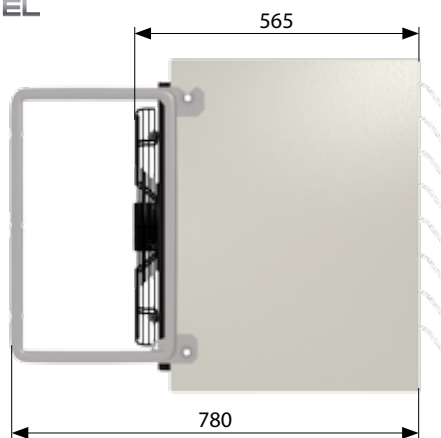

Connecting stub 3/4"

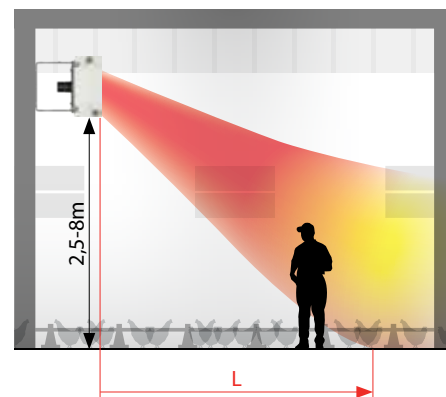



In medium and large size buildings ventilation is often required. By joining air unit heater with mixing chamber you can easily supply fresh air to the object.

VENTILATION



LEO KMFB

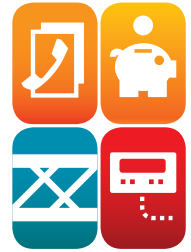

PAGE 32

Heating capacity	9-51 kW
Air flow	540 – 3200 m ³ /h
Weight	45,9 – 52,1 kg
Color	gray
Casing	coated sheet steel* +plastic +aluminium

*uncoated galvanized casing available



THE SIMPLEST VENTILATION SYSTEM FOR LARGE SIZE BUILDINGS

Air heater combined with mixing chamber to create a heating and ventilating device. It is the simplest way to install mechanical ventilation using as little energy as possible without additional systems.

CONTROL SYSTEM

Two types of complete control systems to protect the heat exchanger against freezing. KTS - stepless, KTB - ON/OFF control the dampers.

CONSTRUCTION

Modular construction of sections make possibilities for various ways of montage. Mixing chamber is equipped with filter EU3 class (optional EU4 class). Filter section can be mounted behind adapter – both external and recirculating air will be filtered; or behind damper section – then only external air will be filtered.

EASY MOUNTAGE

Leo KM mixing chamber is delivered in parts (sections), using only few screws it is ready to operate. There are three air inlets in the mixing chamber: two for recirculating air and one for external air.

SELECTION

For further information about the mixing chamber please contact with the local dealer.

LEO KMFB

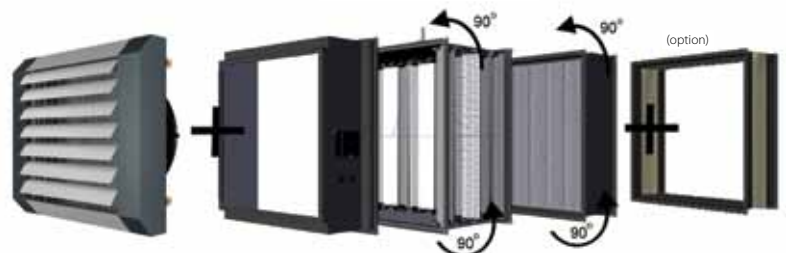



LEO
KMFS

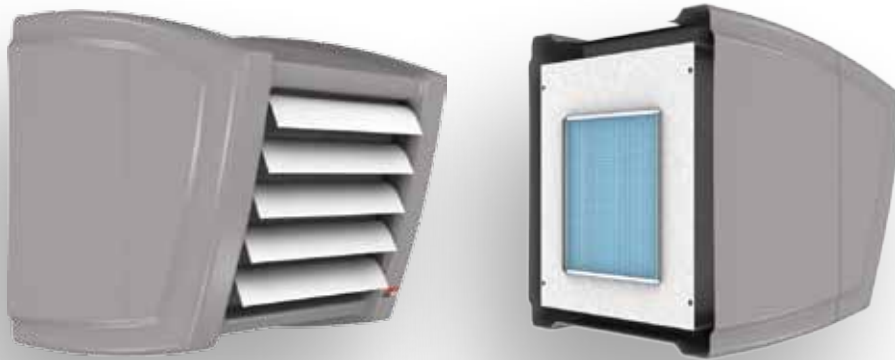

Heating capacity	5-15 kW
Air flow	230-1150 m ³ /h
Weight	32-33,2 kg
Color	grey
Casing	ABS antistatic



THE SIMPLEST VENTILATION OF SMALL AND MEDIUM SIZED AREAS

LEO KM FS delivers fresh air to the room while heating it. It is the simplest mechanical ventilation for small and medium size areas. Its compact dimensions and modern design make it suitable for presentable areas.

DESIGN

The device consists of an air heater with a permanently built-in mixing chamber. It is equipped with EU2 filters mounted on the air inlets. Altogether is enclosed in ABS casing covering both hydraulic and electrical connections.

INNOVATIVE DAMPERS

Innovative design of damper ratio adjustment. Adjustable half-round damper delivers either fresh air, recirculating air or mixed at the same time.

CONTROL SYSTEM

Complete supply control and protection system. Stepless damper position is regulated by a 0-10V actuator. Frost protection thermostat protects the heat exchanger against freezing.

SELECTION

For further information about LEO KM FS please contact with the local dealer.

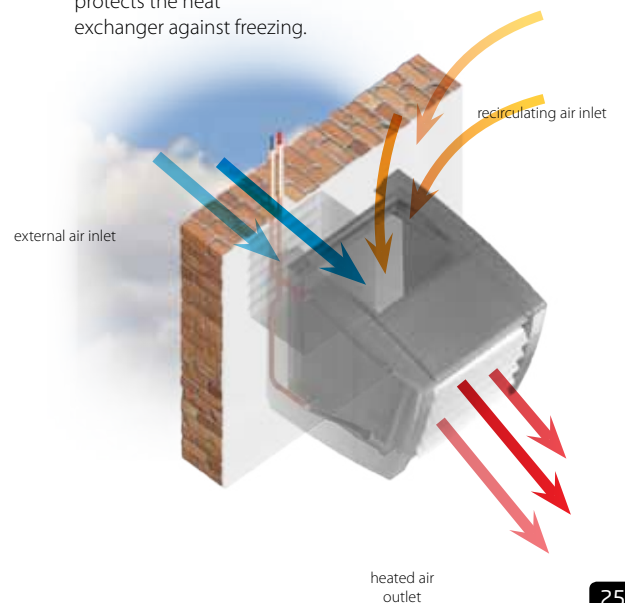

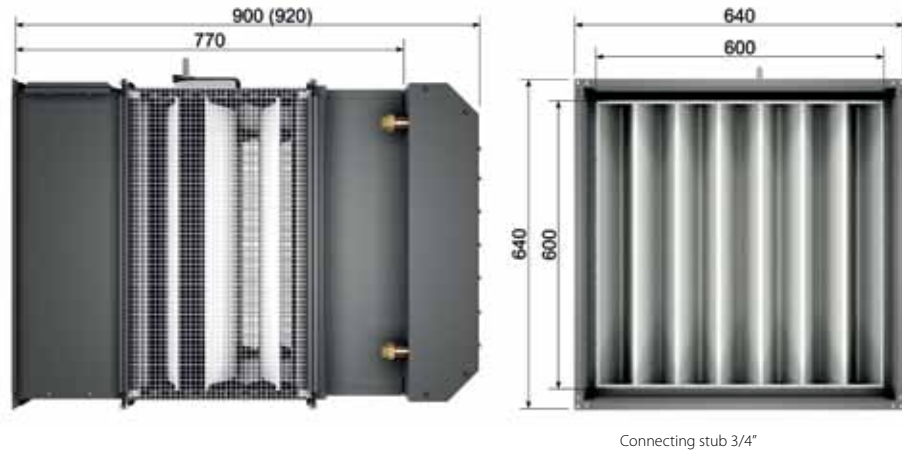

Weight [kg]	KMFS 15 + EU2	KMFB 25 + EU3	KMFB 45 + EU3	KMFB 65 + EU3
Unit	32,0	45,9	47,1	49,4
Unit filled with water	33,2	46,9	49,1	52,1
Air stream range [m]	KMFS 15 + EU2	KMFB 25 + EU3	KMFB 45 + EU3	KMFB 65 + EU3
L*	8	18	16,5	15,5

* range of isothermal horizontal stream, limit speed 0,5 m/s

LEO KMFS + EU2				LEO KMFB 25 + EU3				LEO KMFB 45 + EU3				LEO KMFB 65 + EU3				
V = 1150 m ³ /h**				V = 3200 m ³ /h**				V = 3000 m ³ /h**				V = 2800 m ³ /h**				
Tp1	PT	Qw	Δpw	Tp2	PT	Qw	Δpw	Tp2	PT	Qw	Δpw	Tp2	PT	Qw	Δpw	Tp2
°C	kW	l/h	kPa	°C	kW	l/h	kPa	°C	kW	l/h	kPa	°C	kW	l/h	kPa	°C
Tw1/Tw2 = 90/70°C																
-25	21,6	952	6,9	22	30,0	1322	15,9	-1,5*	54,5	2405	23,1	21,0	71,2	3142	35,8	39,0
-22	20,8	917	6,5	24	28,9	1276	14,8	1,0*	52,5	2319	21,6	23,0	68,6	3029	33,5	40,0
-20	20,3	894	6,2	25	28,2	1245	14,2	3,0*	51,3	2262	20,6	24,0	67,0	2955	32,0	41,0
-15	19,0	838	5,5	28	26,5	1169	12,6	7,0	48,1	2121	18,4	27,0	62,8	2771	28,4	44,0
-10	17,7	783	4,8	31	24,8	1095	11,2	11,0	44,9	1983	16,2	30,0	58,7	2592	25,1	46,0
-5	16,5	729	4,2	34	23,2	1021	9,9	15,0	41,9	1848	14,3	33,0	54,8	2417	22,1	48,0
0	15,3	676	3,7	37	21,5	949	8,6	19,0	38,9	1716	12,4	36,0	50,9	2246	19,3	50,0
5	14,1	624	3,2	40	19,9	877	7,5	22,5	35,9	1586	10,8	39,0	47,1	2079	16,8	52,0
10	13,0	572	2,7	42	18,3	807	6,4	26,0	33,0	1458	9,2	41,5	43,4	1915	14,4	54,0
15	11,8	522	2,3	45	16,7	737	5,4	30,0	30,2	1333	7,8	44,0	39,8	1755	12,3	56,0
20	10,7	472	1,9	48	15,1	668	4,5	34,0	27,4	1209	6,6	47,0	36,2	1597	10,4	58,0
Tw1/Tw2 = 80/60°C																
-25	19,2	843	5,7	17	26,6	1171	13,0	-4,0*	48,6	2137	19,1	16,0	63,8	2805	29,8	32,0
-22	18,4	810	5,3	19	25,6	1125	12,1	-2,0*	46,7	2053	17,8	18,0	61,3	2695	27,7	33,5
-20	17,9	787	5,0	20	24,9	1095	11,5	0,0*	45,5	1997	16,9	19,0	59,7	2622	26,4	35,0
-15	16,7	732	4,4	23	23,2	1021	10,1	4,0*	42,3	1860	14,8	22,0	55,6	2443	23,2	37,0
-10	15,4	678	3,8	26	21,6	948	8,8	8,0	39,3	1725	12,9	25,0	51,6	2269	20,2	39,0
-5	14,2	625	3,3	29	19,9	875	7,6	12,0	36,3	1593	11,1	28,0	47,8	2098	17,5	41,0
0	13,1	573	2,8	31	18,3	804	6,5	16,0	33,3	1464	9,6	31,0	44,0	1931	15,1	43,0
5	11,9	522	2,4	34	16,7	734	5,5	20,0	30,4	1336	8,1	33,5	40,2	1768	12,8	45,0
10	10,7	472	2,0	37	15,1	665	4,6	23,5	27,6	1211	6,8	36,0	36,6	1607	10,8	47,0
15	9,6	423	1,6	39	13,6	596	3,8	27,0	24,8	1088	5,6	39,0	33,0	1450	9,0	49,0
20	8,5	374	1,3	42	12,0	528	3,0	31,0	22,0	967	4,5	42,0	29,5	1296	7,3	51,0
Tw1/Tw2 = 70/50°C																
-25	16,8	735	4,6	12	23,3	1019	10,4	-7,0*	42,7	1870	15,4	11,0	56,4	2470	24,3	26,0
-22	16,0	702	4,2	14	22,3	975	9,6	-4,0*	40,9	1788	14,2	13,0	54,0	2362	22,4	27,0
-20	15,5	680	4,0	15	21,6	945	9,0	-3,0*	39,6	1734	13,4	14,0	52,4	2292	21,2	28,0
-15	14,3	626	3,4	18	19,9	872	7,8	1,0*	36,6	1600	11,6	17,0	48,4	2117	18,4	30,0
-10	13,1	573	2,9	20	18,3	800	6,7	5,0*	33,6	1468	9,9	20,0	44,5	1947	15,8	32,0
-5	11,9	522	2,5	23	16,7	730	5,6	9,0	30,6	1339	8,4	23,0	40,7	1780	13,4	34,0
0	10,8	471	2,0	26	15,1	659	4,7	13,0	27,7	1212	7,0	25,5	37,0	1617	11,3	36,5
5	9,6	420	1,7	29	13,5	590	3,8	17,0	24,9	1087	5,8	28,0	33,3	1457	9,3	38,5
10	8,5	371	1,3	31	11,9	522	3,1	21,0	22,1	965	4,6	31,0	29,7	1300	7,6	40,0
15	7,3	321	1,0	34	10,4	454	2,4	24,5	19,3	844	3,7	34,0	26,2	1146	6,1	42,0
20	6,2	272	0,8	36	8,8	387	1,8	28,0	16,6	725	2,8	36,0	22,7	994	4,7	44,0

V – air flow
PT – heating capacity
Tp1 – inlet air temperature
Tp2 – outlet air temperature

Tw1 – inlet water temperature
Tw2 – outlet water temperature
Qw – heating water stream
Δpw – water pressure drop

* not recommended

** air volume while 100% opening of fresh air damper

	KMFS S	KMFS M	KMFB 25/45/65
Power supply	230 V/50 Hz	230 V/50 Hz	230 V/50 Hz
Max. power consumption	92 W	57,5 W	280 W
Max. current consumption	0,4 A	0,25 A	1,2 A
IP/Insulation class	54/F	54/F	54/F
Acoustic pressure level	45 dB(A)	45 dB(A)	51 dB(A)

Acoustic pressure level measured in the room of average sound absorption, capacity 1500m³, at distance of 5m from the unit

	KMFS	KMFB 25/45/65
Max. water temperature	95°C	130°C
Max. water pressure	1,6 MPa	

Technical data concerning supplying with other water parameters are available upon request at Sales office.



	LEO D 2	LEO D 2.2
Air flow	5100 m ³ /h	10200
Weight	11,0	22,0
Color	grey	
Casing	steel + PA	

LEO D 2, LEO DT 2



	LEO D2	LEO D 2.2
Power supply	230 V/50 Hz	
Max. power consumption	280 W	560 W
Max. current consumption	1,2 A	2,4 A
IP/Insulation class	54/F	
Acoustic pressure level	51 dB(A)	53 dB(A)

LEO D 2.2, LEO DT 2.2



Acoustic pressure level measured in a room of average sound absorption, capacity 1500 m³, at distance of 5m from the unit.



CASING

The materials used guarantees proper parameters - both thermal and mechanical. Recyclable. Modern design corresponding with Leo FB.

AIR BLADES

There are 4 sets of blades. Stepless, manual regulation of the inclination angle of each blade for precise air stream separation.

FAN

Fan provides very efficient delivery of heated air. Blades are made of plastic for weight reduction. Special shape of blades ensures quiet operation of the unit.

THERMOSTAT

Available in LEO DT. If air temperature in upper levels rises up to the pre-set value the fan switches on so that the heat is brought back to lower levels. Mounted on the lateral side of the device.

AIR NOZZLE

Specially designed shape of the nozzle reduces noise during air flow and increases the air volume.

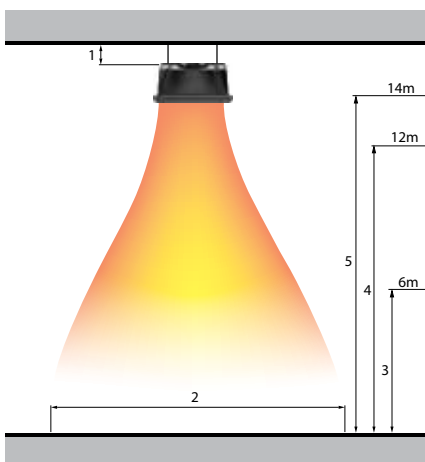

Recommendation of installation and air stream range of unit.

1. min. 300mm
2. ~ 10 x 10 m (all blades directed down)
3. Min. 6 m – LEO D 2/DT 2
4. Max. 12m – LEO D 2/DT 2
5. Max. 14m – LEO D 2.2/DT 2.2

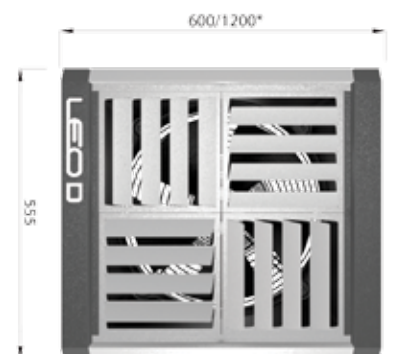

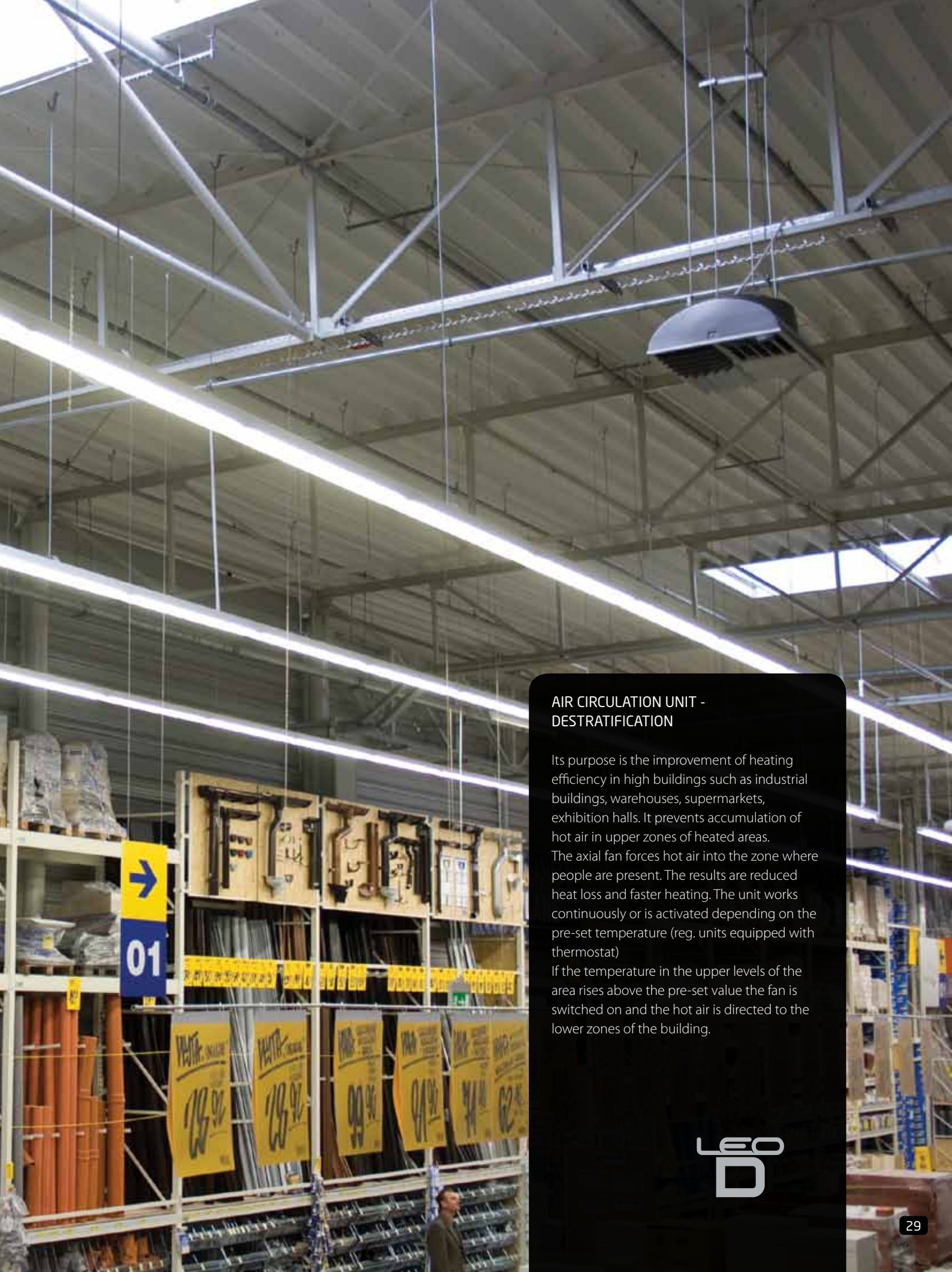

AIR CIRCULATION UNIT - DESTRATIFICATION

Its purpose is the improvement of heating efficiency in high buildings such as industrial buildings, warehouses, supermarkets, exhibition halls. It prevents accumulation of hot air in upper zones of heated areas. The axial fan forces hot air into the zone where people are present. The results are reduced heat loss and faster heating. The unit works continuously or is activated depending on the pre-set temperature (reg. units equipped with thermostat)

If the temperature in the upper levels of the area rises above the pre-set value the fan is switched on and the hot air is directed to the lower zones of the building.





S TYPE CONTROL

ON/OFF control. The heaters operation is regulated by a thermostat that activates the unit in case of a temperature drop below the pre-set value. The fan is controlled manually by a 5-step regulator.

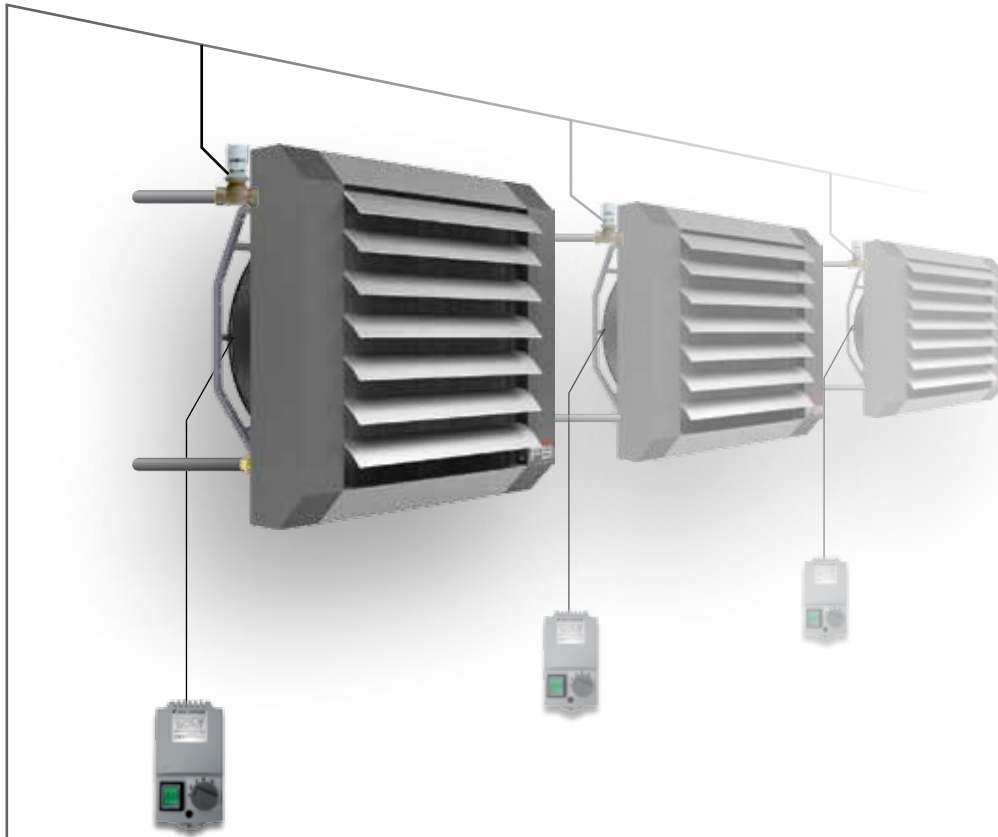

ST1



SRV2d + TR + RA







ST2



SRV2d + TR + RD



or

1. VALVES WITH ACTUATOR	2. THERMOSTAT	3. FAN SPEED REGULATOR
 SRV2d (SRS) - two-way valve with actuator 3/4" (1/2")	 RA - room thermostat	 TRs - 3-step transformer fan speed regulator (0,5A)
 SRV3d (SRS3d) - three-way valve with actuator 3/4" (1/2")	 RD - room thermostat with programmable calendar	 TR (TRd) - 5-step transformer fan speed regulator 1,5A (3,0A)

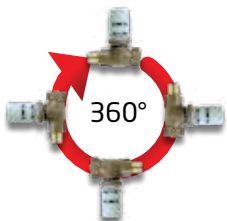

CONTROL SYSTEM







M TYPE CONTROL

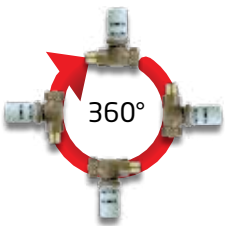
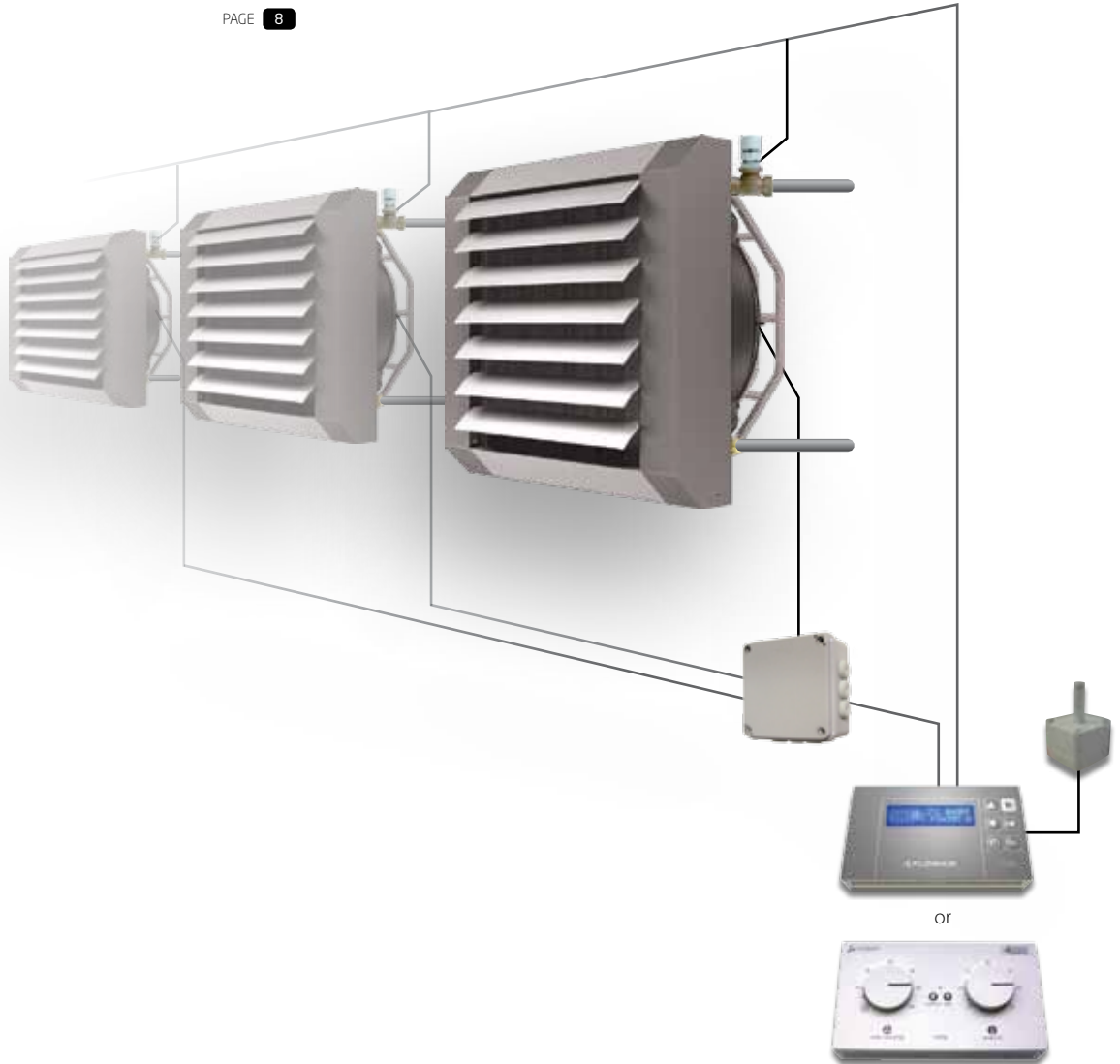

PAGE 8

The units are equipped with a built-in regulator which is fed with a voltage signal by an external 0-10V control panel. The range between 0-10V equals 0-100% of the fan speed. The VNT 20 and VNT LCD panels can work in AUTO mode- which means the adjusting of the heat capacity depending on changing heat conditions of the area. When the heat demand increases (temperature falls) the fan speed rises. As a result valves are unnecessary. In MANUAL mode the hot water supply is being switched off after reaching pre-set temperature and the fan speed is controlled manually by the user.



1. VALVES WITH ACTUATOR	2. THERMOSTAT	3. EXTERNAL TEMPERATURE SENSOR	4. SIGNAL DISTRIBUTOR
 SRV2d (SRS) - two-way valve with actuator 3/4" (1/2")	 VNT20 - control panel with built-in room thermostat	 PT-1000 IP20 - external temperature sensor IP20 protection class	 R10 - junction box
 SRV3d (SRS3d) - three-way valve with actuator 3/4" (1/2")	 VNTLCD - control panel with thermostat, weekly calendar and display	 PT-1000 IP65 - external temperature sensor IP65 protection class	



LEO KM CONTROL SYSTEMS

KTB CONTROL

The supply and control equipment is dedicated to the water heater with mixing chamber. The unit controls delivery of fresh air to the room by opening or closing the damper. In closed position the heater is running on recirculation air. It can be connected with exhaust fans to control their performance. To control several units there is available a master/slave mode or buffer - for more information please contact with the local dealer.

1. CONTROL SYSTEM



KTE
supply and control box

2. DAMPER ACTUATOR



SP ON/OFF
two positions

3. FROST PROTECTION THERMOSTAT



TPR
protects the heat exchanger from freezing

KTS CONTROL

The supply and control equipment is dedicated to the water heater with mixing chamber. The main difference is that the damper actuator is controlled steplessly which means both fresh and recirculated air can be handled at once. It may also control the exhaust fans. To control several units there is available a master/slave mode or buffer - for more information please contact with the local dealer.

1. CONTROL SYSTEM



KTE
supply and control box

2. DAMPER ACTUATOR



SP 0-10
stepless regulation of dampers opening

3. FROST PROTECTION THERMOSTAT



TPR
protects the heat exchanger from freezing





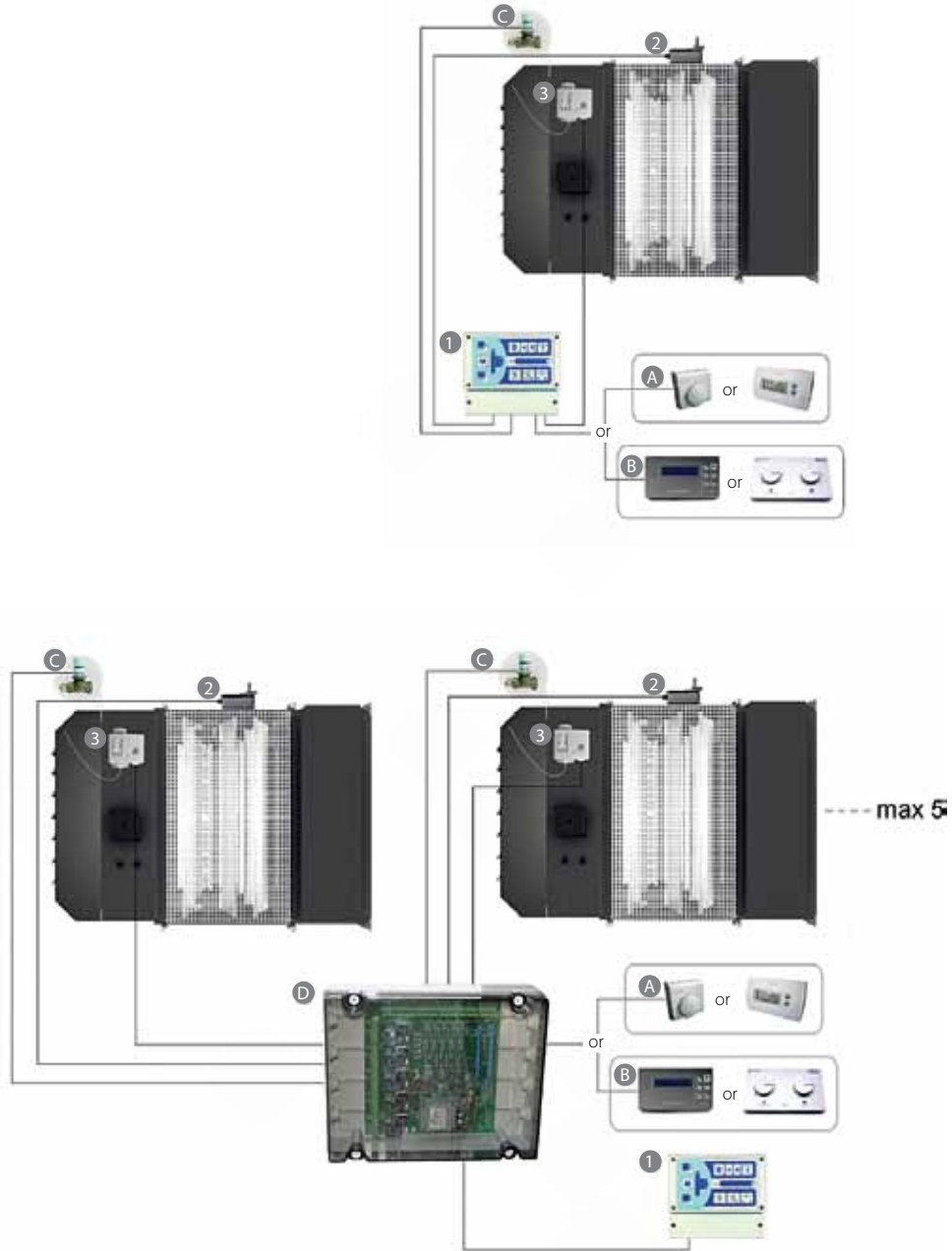

BUFFER

Buffer is a distributor of supplying and steering signals. It supplies fan of Leo water heater and exhaust fan. Buffer gives also signals of various dangerous: filters high pollution, anti freeze alarms and failure of exhaust fan (equipped with external TK). It is possible to connect up to 5 heaters and 5 exhaust fans.





OPTIONAL EQUIPMENT

A. THERMOSTATS (S - TYPE CONTROL)		B. THERMOSTATS WITH SPEED ADJUSTER (M - TYPE CONTROL)		C. VALVE WITH ACTUATOR	D. BUFFER
					
RA - room thermostat	RD - room thermostat with programmable calendar	VNT20 - control panel with built-in room thermostat	VNTLCD - control panel with thermostat, weekly calendar and display	SRV2d - two-way valve with actuator	Signal distributor for several units

QUALITY AND RELIABILITY

FLOWAIR makes every effort to guarantee that Leo heaters will provide long and failure free operation. It is necessary to use high-class components and keep high standards both at production and quality control to create a reliable product.

Our suppliers are renowned European producers. We cooperate with companies like EBM papst, Ziehl-Abegg (fans), Honeywell, Siemens, Breve Tufvassons (automatic control).



FLOWAIR - CREDIBLE BUSINESS PARTNER

We strive to develop long-term relationship with our partners. We base our contacts on FAIR PLAY principles. We offer professional help during the whole investment process - starting with selection stage of units through its assembling up to its service.

CERTIFICATES

The highest quality of FLOWAIR's products is confirmed by international certificates (ROSTEST) as well as CE declarations of conformity of European directives. The products meet health, safety and environmental protection requirements.

ADVICE AND SERVICE

EDUCATION

The qualified team of engineers conducts product and service related training in our Training Center situated in PSTP (Pomeranian Science and Technology Park). Apart from specialists we invite also students of faculties related to this industry. The units are tested in real conditions in our laboratory. The experiments and tests let us gain additional skills necessary for specialists.

QUICK DELIVERY

In response to our customers needs we have introduced the continuous monitoring of stock levels so that the customer can be supplied with most of the units within 48 hours.

ASSISTANCE IN UNIT SELECTION

Professional software estimating the heat demand is available and at your disposal. Our qualified staff will assist you with the selection and quantity of units which meet your requirements.

AFTER-SALE SERVICE AND WARRANTY

The customer, who bought the units is still very important partner for us. We offer a 24 month warranty. It is also possible to extend the warranty (please contact Service Department).



CONTACT



WE OFFER TECHNICAL AND PROFESSIONAL SUPPORT

The professional technical staff will help in selecting units that fits your needs best.



PREPARE BASIC INFORMATION

Please prepare information concerning your project (location, dimension, heat transfer coefficient or type and thickness of insulation).

PLACING THE ORDER

Please contact with the local dealer.

CONTACT DATA

Please contact with the local dealer.

CONFIRMATION

In response to your order we will send you a pro-forma confirming the order, sales conditions and delivery date.

UNIT SELECTION

Our Technical Department will prepare the optimal solution in scope of type and number of units and controls.

DELIVERY

The ordered goods will be delivered within 48 hours for further details please contact our local dealer. More information on www.flowair.com



QUOTATION

You will get the quotation and sales conditions.

Based on the knowledge, experience and state of the art solutions we can advise our customers the system which matches their needs best. We are the expert for economic heating of large buildings. You are welcome to contact us.





SAVINGS



MODERN DESIGN



3D-CONSOLE



MIXING CHAMBER



CONTROL SYSTEM



M SYSTEM



S TYPE CONTROL



EQUIPPED WITH EC FAN



EQUIPPED WITH AN EXPLOSION-PROOF FAN



STAINLESS STEEL CASING



ELEGANT BUILDINGS



AGRI-CULTURAL BUILDINGS



INDUSTRIAL BUILDINGS



24 MONTHS WARRANTY



SERVICE



SELECTION

www.flowair.com

